

- ★ 100% EAS Guaranteed
- ★ Green Device Available
- ★ Super Low Gate Charge
- ★ Excellent CdV/dt effect decline
- ★ Advanced high cell density Trench technology

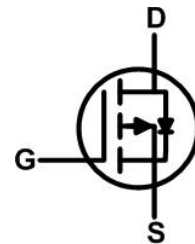
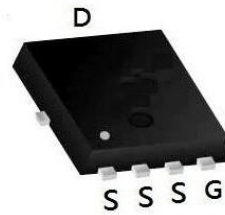

**Product Summary**

BVDSS	RDSON	ID
-30V	10.3mΩ	-45A

**Description**

The XXW45P03D is the high cell density trenched P-ch MOSFETs, which provide excellent RDSON and gate charge for most of the synchronous buck converter applications.

The XXW45P03D meet the RoHS and Gree Product requirement 100% EAS guaranteed with full function reliability approved.

**PDFN3333-8L Pin Configuration**

**Absolute Maximum Ratings (TA=25°C unless otherwise noted)**

Parameter		Symbol	Value	Unit
Drain-Source Voltage		V <sub>DS</sub>	-30	V
Gate-Source Voltage		V <sub>GS</sub>	±20	V
Continuous Drain Current	T <sub>C</sub> = 25°C	I <sub>D</sub>	-45	A
	T <sub>C</sub> = 100°C		-23	
Pulsed Drain Current <sup>1</sup>		I <sub>DM</sub>	-120	A
Single Pulse Avalanche Energy <sup>2</sup>		EAS	45	mJ
Total Power Dissipation	T <sub>C</sub> = 25°C	P <sub>D</sub>	29.7	W
Operating Junction and Storage Temperature Range		T <sub>J</sub> , T <sub>STG</sub>	-55 to 150	°C

**Thermal Characteristics**

Parameter	Symbol	Value	Unit
Thermal Resistance from Junction-to-Ambient <sup>3</sup>	R <sub>θJA</sub>	78	°C/W
Thermal Resistance from Junction-to-Case	R <sub>θJC</sub>	4.2	°C/W

**Electrical Characteristics (T<sub>J</sub>=25°C unless otherwise noted)**

Parameter	Symbol	Test Conditions	Min.	Typ.	Max.	Unit
<b>Static Characteristics</b>						
Drain-Source Breakdown Voltage	<b>V<sub>(BR)DSS</sub></b>	V <sub>GS</sub> = 0V, I <sub>D</sub> = -250μA	-30	-	-	V
Gate-body Leakage current	<b>I<sub>GSS</sub></b>	V <sub>DS</sub> = 0V, V <sub>GS</sub> = ±20V	-	-	±100	nA
Zero Gate Voltage Drain Current	T <sub>J</sub> = 25°C	V <sub>DS</sub> = -30V, V <sub>GS</sub> = 0V	-	-	-1	μA
	T <sub>J</sub> = 100°C		-	-	-100	
Gate-Threshold Voltage	<b>V<sub>GS(th)</sub></b>	V <sub>DS</sub> = V <sub>GS</sub> , I <sub>D</sub> = -250μA	-1.0	-1.6	-2.5	V
Drain-Source On-Resistance <sup>4</sup>	<b>R<sub>DS(on)</sub></b>	V <sub>GS</sub> = -10V, I <sub>D</sub> = -15A	-	10.3	13.5	mΩ
		V <sub>GS</sub> = -4.5V, I <sub>D</sub> = -10A	-	15	20	
Forward Transconductance <sup>4</sup>	<b>g<sub>fs</sub></b>	V <sub>DS</sub> = -10V, I <sub>D</sub> = -15A	-	15	-	S
<b>Dynamic Characteristics<sup>5</sup></b>						
Input Capacitance	<b>C<sub>iss</sub></b>	V <sub>DS</sub> = -15V, V <sub>GS</sub> = 0V, f = 1MHz	-	1405	-	pF
Output Capacitance	<b>C<sub>oss</sub></b>		-	177	-	
Reverse Transfer Capacitance	<b>C<sub>rss</sub></b>		-	147	-	
Gate Resistance	<b>R<sub>g</sub></b>	f = 1.0MHz	-	11	-	Ω
<b>Switching Characteristics<sup>5</sup></b>						
Total Gate Charge	<b>Q<sub>g</sub></b>	V <sub>GS</sub> = -10V, V <sub>DS</sub> = -15V, I <sub>D</sub> = -15A	-	30	-	nC
Gate-Source Charge	<b>Q<sub>gs</sub></b>		-	5.5	-	
Gate-Drain Charge	<b>Q<sub>gd</sub></b>		-	8	-	
Turn-on Delay Time	<b>t<sub>d(on)</sub></b>	V <sub>GS</sub> = -10V, V <sub>DD</sub> = -15V, R <sub>G</sub> = 3Ω, I <sub>D</sub> = -15A	-	10	-	ns
Rise Time	<b>t<sub>r</sub></b>		-	15	-	
Turn-off Delay Time	<b>t<sub>d(off)</sub></b>		-	110	-	
Fall Time	<b>t<sub>f</sub></b>		-	70	-	
<b>Drain-Source Body Diode Characteristics</b>						
Diode Forward Voltage <sup>4</sup>	<b>V<sub>SD</sub></b>	I <sub>S</sub> = -1A, V <sub>GS</sub> = 0V	-	-	-1.2	V
Continuous Source Current	T <sub>C</sub> = 25°C	<b>I<sub>S</sub></b>	-	-	-45	A

Note :

1. Repetitive rating, pulse width limited by junction temperature T<sub>J(MAX)</sub> = 150°C.
2. The EAS data shows Max. rating . The test condition is V<sub>DD</sub> = -25V, V<sub>GS</sub> = -10V, L = 0.1mH, I<sub>AS</sub> = -30A.
3. The data tested by surface mounted on a 1 inch<sup>2</sup> FR-4 board with 2OZ copper, The value in any given application depends on the user's specific board design.
4. The data tested by pulsed , pulse width ≤ 300us , duty cycle ≤ 2%.
5. This value is guaranteed by design hence it is not included in the production test.

**Typical Characteristics**

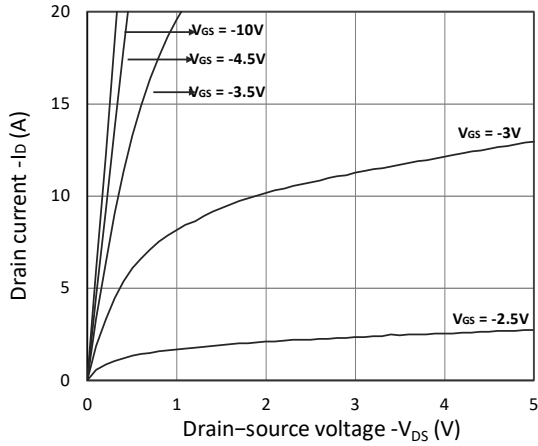


Figure 1. Output Characteristics

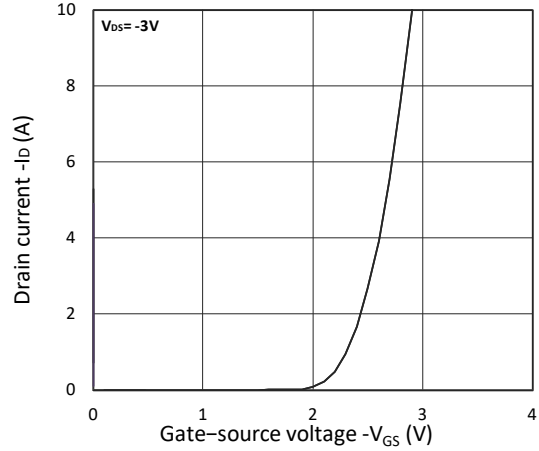


Figure 2. Transfer Characteristics

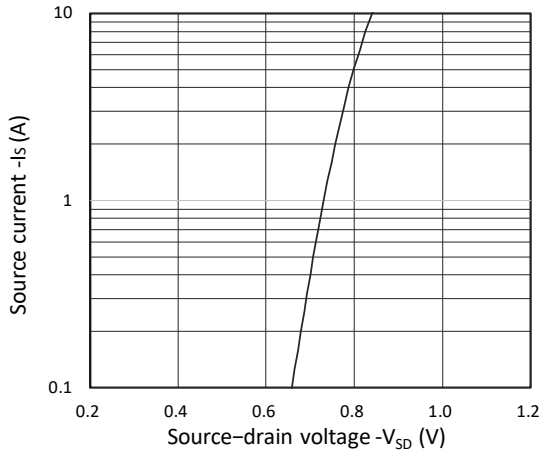


Figure 3. Forward Characteristics of Reverse

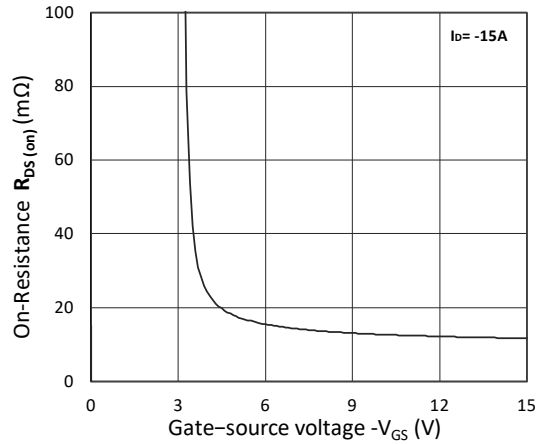


Figure 4.  $R_{DS(ON)}$  vs.  $V_{GS}$

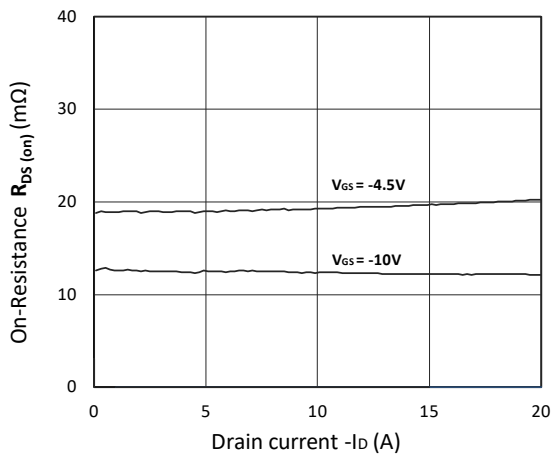


Figure 5.  $R_{DS(ON)}$  vs.  $I_D$

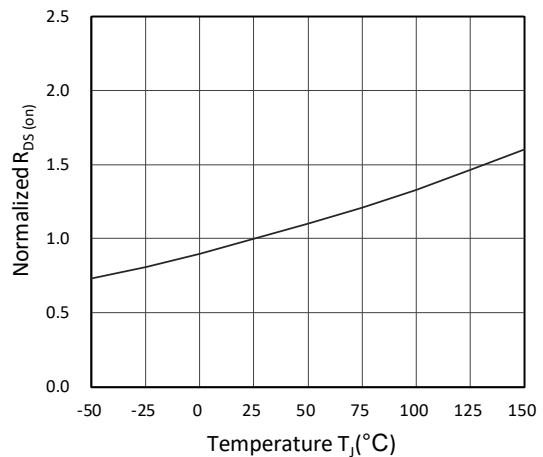


Figure 6. Normalized  $R_{DS(ON)}$  vs. Temperature

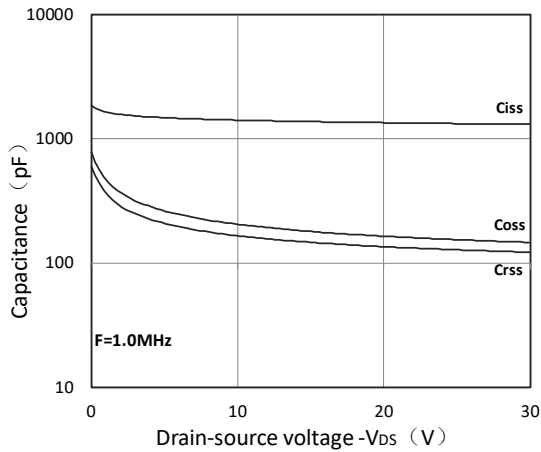


Figure 7. Capacitance Characteristics

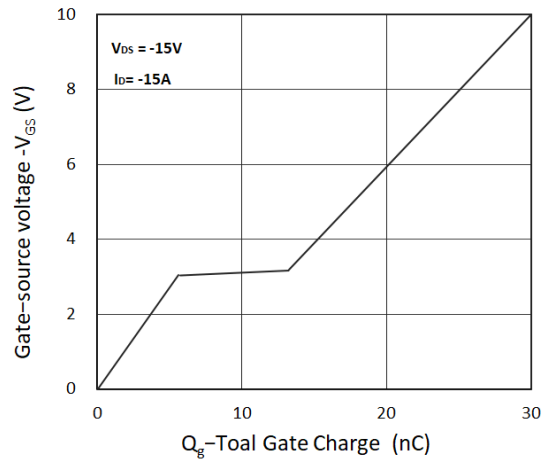


Figure 8. Gate Charge Characteristics

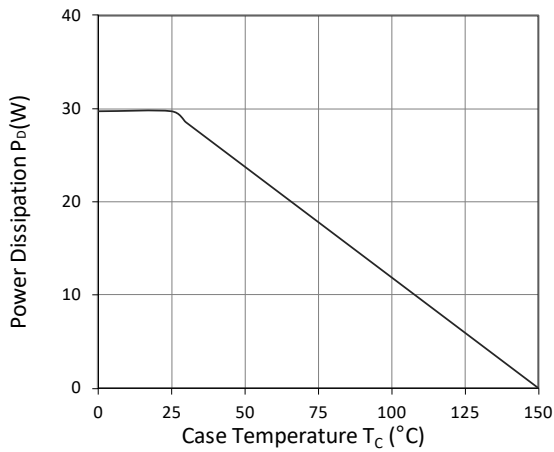


Figure 9. Power Dissipation

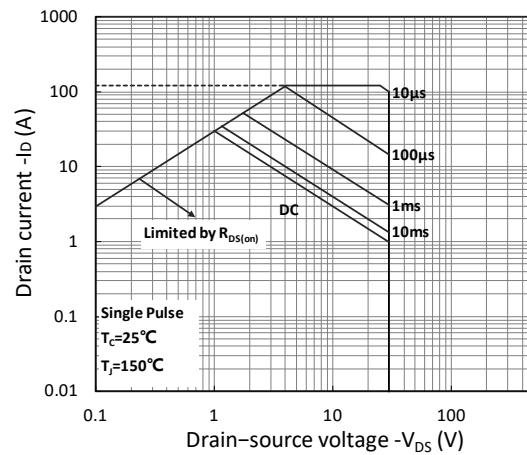


Figure 10. Safe Operating Area

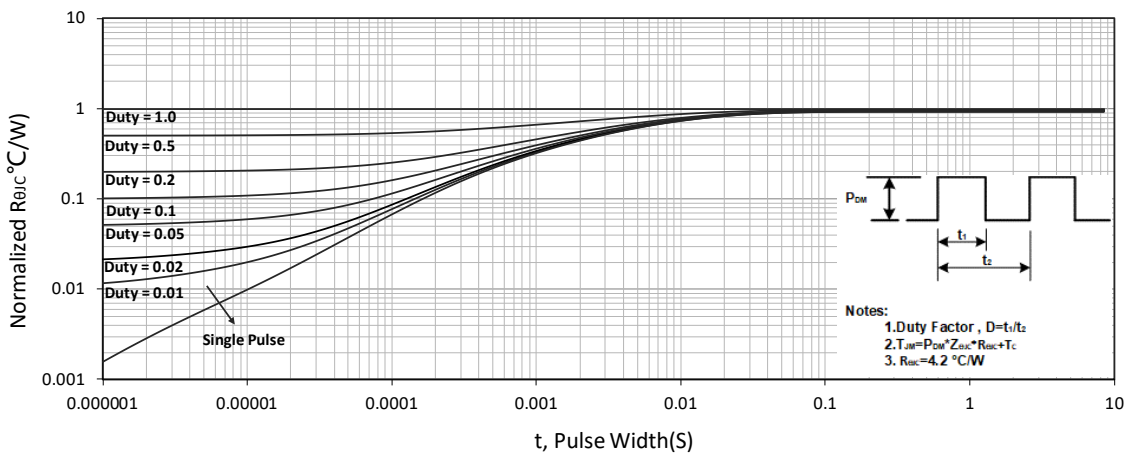
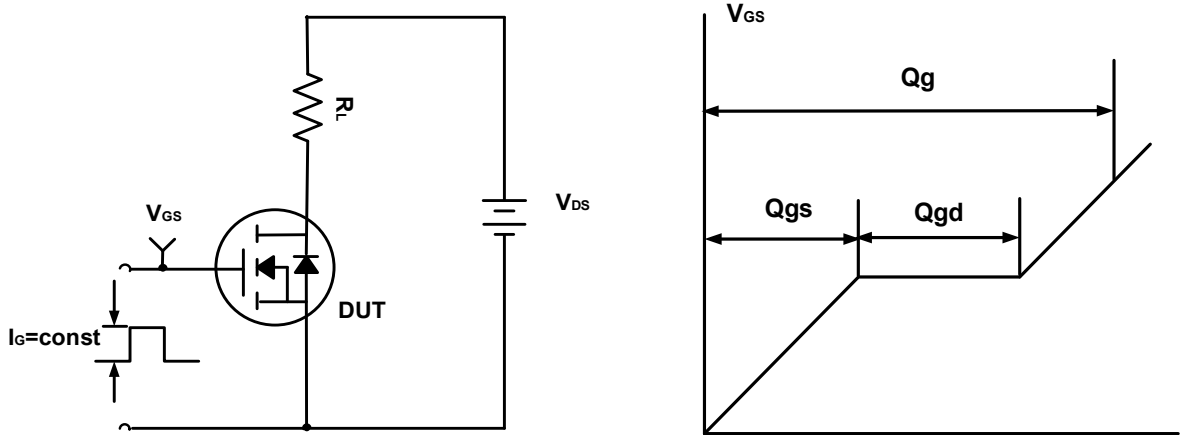
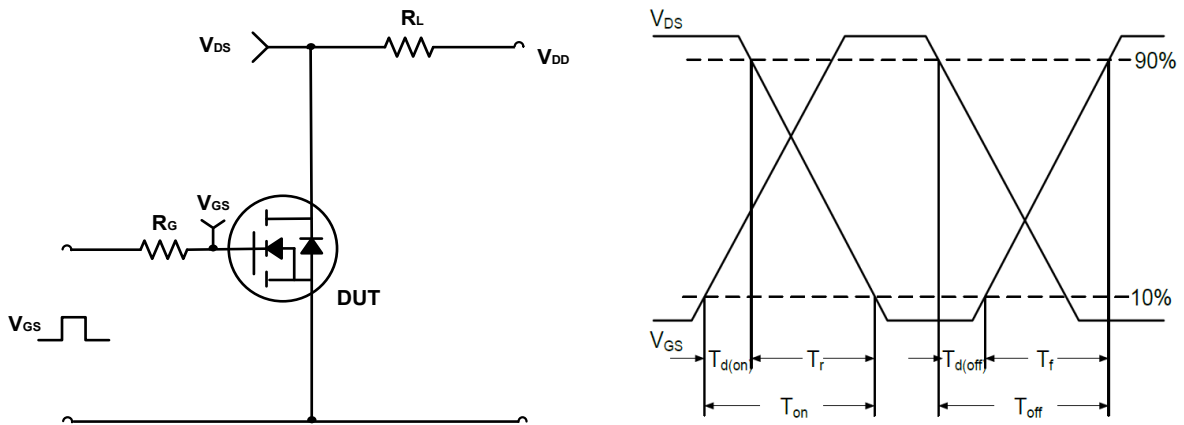


Figure 11. Normalized Maximum Transient Thermal Impedance

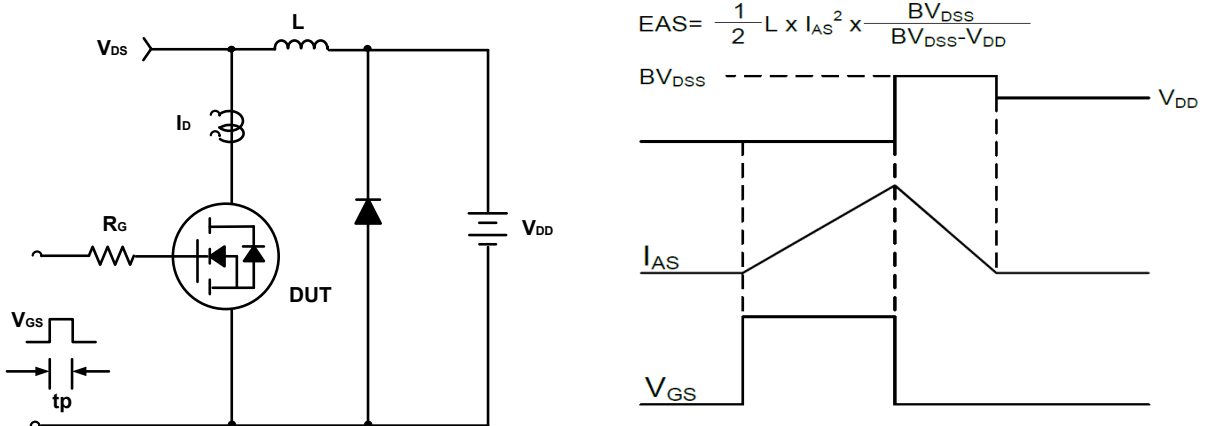
**Test Circuit**



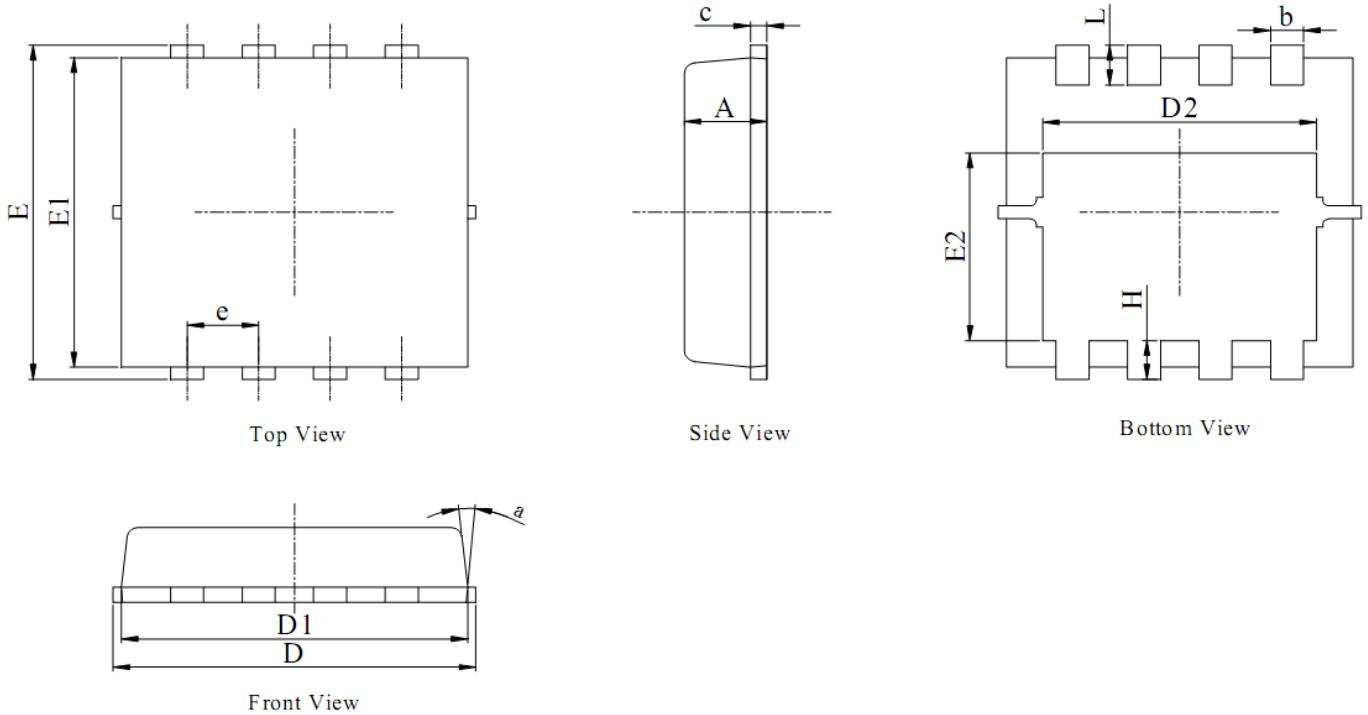
**Figure A. Gate Charge Test Circuit & Waveforms**



**Figure B. Switching Test Circuit & Waveforms**

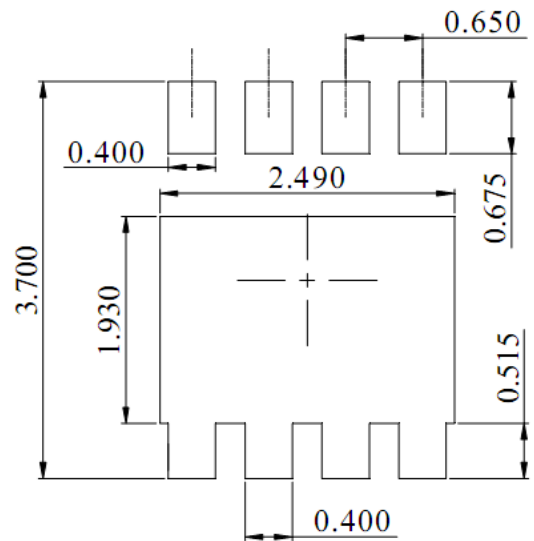


**Figure C. Unclamped Inductive Switching Circuit & Waveforms**

**Package Mechanical Data-PDFN3333-8L-Single**

**NOTES:**

1. DIMENSIONING AND TOLERANCING PER ASME Y14.5M,1994.
2. ALL DIMENSIONS IN MILLIMETER (ANGLE IN DEGREE).
3. DIMENSIONS D1 AND E1 DO NOT INCLUDE MOLD FLASH PROTRUSIONS OR GATE BURRS.

DIM.	MILLIMETER		
	MIN.	NOM.	MAX.
A	0.70	0.75	0.80
b	0.25	0.30	0.35
c	0.10	0.20	0.25
D	3.00	3.15	3.25
D1	2.95	3.05	3.15
D2	2.39	2.49	2.59
E	3.20	3.30	3.40
E1	2.95	3.05	3.15
E2	1.70	1.80	1.90
e	0.65 BSC		
H	0.30	0.40	0.50
L	0.25	0.40	0.50
a	---	---	15°



DIMENSIONS:MILLIMETERS